

RoHS Compliant



READ THE INSTRUCTION MANUAL

# INSTRUCTION MANUAL

MANOSTAR SWITCH  
MS30

TR-MS30-E07

 **Yamamoto Electric Works Co., Ltd.**

〒653-0031 1-2-3, Nishi-shiriike-cho, Nagata-ku, Kobe, Japan

TEL : 078-631-6000

FAX : 078-631-6020

## TABLE OF CONTENTS

	PAGE
INTRODUCTION .....	1
I . PRECAUTIONS .....	1
II . SPECIFICATIONS OF MANOSTAR SWITCH MS30 .....	2
III . INSTALLATION	
1. Caution of service condition .....	5
2. Installation of MS30 .....	5
3. Piping material .....	5
4. Pressure of measurement and connection of piping .....	5
5. Caution of piping .....	6
6. Installation position .....	6
7. Wiring .....	6
IV . SETTING OF PRESSURE	
1. Switch contact configuration .....	7
2. Setting of upper limit/ lower limit .....	7
3. Reset time .....	8
V . ABOUT BUILT-IN MICRO SWITCH	
1. Material of contact .....	8
2. Contact material and applicable mechanism for low voltage and low current circuit .....	8
3. Protection of contact of switch .....	9
4. About measured gas and contact failure .....	10
VI . LINE PART ACCESSORIES .....	10
VII . PERIODIC INSPECTION .....	11
VIII . PRODUCT WARRANTY .....	11

## INTRODUCTION

Thank you very much for purchasing of "MANOSTAR SWITCH MS30".

 Caution	<p>To ensure your safety in using this instrument :</p> <ul style="list-style-type: none"><li>• Be sure to read the instruction manual carefully before using the instrument so that you can use it properly.</li></ul> <p>Wrong use may result in failure of the instrument and lead to its damage and accident. This manual should be kept in a proper place so that you can refer to it any time you need.</p>
--	---

## I . PRECAUTIONS

 <b>Warning</b>	
<ul style="list-style-type: none"><li>• <b>Do not use this instrument where flammable gas is present.</b> The instrument is not explosion-proof. Do not use the instruments in the circumstance where flammable gas is present. It may cause explosion.</li><li>• <b>Do not use the instrument at the place where corrosive gas is present.</b> The instrument is not corrosion resistance construction. Measuring corrosive gas may corrode the receiving element and housing material of the instrument. It is expected that corrosive gas leaked out of the instrument will harm a person.</li><li>• <b>Do not apply the pressure to the instrument more than it can withstand.</b> The diaphragm and the retainer are broken if the pressure exceeding withstanding pressure of the pressure receiving element is applied to the instrument. The case body of the instrument is broken if the pressure exceeding withstanding pressure of the instrument body is applied to the instrument.</li><li>• <b>The instrument is measurable for air and non-corrosive gas only.</b> The machine is exclusive use of dry air (90% RH or less). Using measuring the water or oil it may be damaged and causes the accident.</li><li>• <b>Avoid using where the instrument is subject to many vibration and impact.</b> Using the instrument where intensified vibration and impact may be damaged the instrument. It is expected that gas leaks of the instrument which harms a parson.</li><li>• <b>Do not exceed rated voltage in using.</b> Using the instrument by exceeding rated voltage may cause fire or electric shock.</li><li>• <b>Wire correctly.</b> Incorrect wiring may cause fire.</li><li>• <b>Do not exceed rated surrounding temperature, humidity and altitude in use.</b> Using the instrument by exceeding rated surrounding temperature and humidity and altitude it may be damaged and cause the accident.</li><li>• <b>Do not disassemble or reconstruct the instrument.</b> It may void the warranty.</li></ul>	

 <b>Caution</b>	
<ul style="list-style-type: none"><li>• <b>As to where to install and how to install this instrument, be sure to follow the instruction manual provided so as to ensure a proper method.</b></li><li>• <b>Use the instrument indoors.</b></li><li>• <b>In case of not being installed in dry and well-kept clean locations, the instrument must be enclosed in box of min. Protection degree IP54.</b></li><li>• <b>Do not use organic solvent for cleaning.</b> Use a cloth soaked with water-diluted neutral detergent to wipe the surface of a product. Using of organic solvent causes damage on the surface.</li><li>• <b>Dropping the instrument</b> If the product is dropped onto a desk or floor, not only its exterior but also interior mechanism is broken.</li></ul>	

## II. SPECIFICATIONS OF MANOSTAR SWITCH MS30

Types :

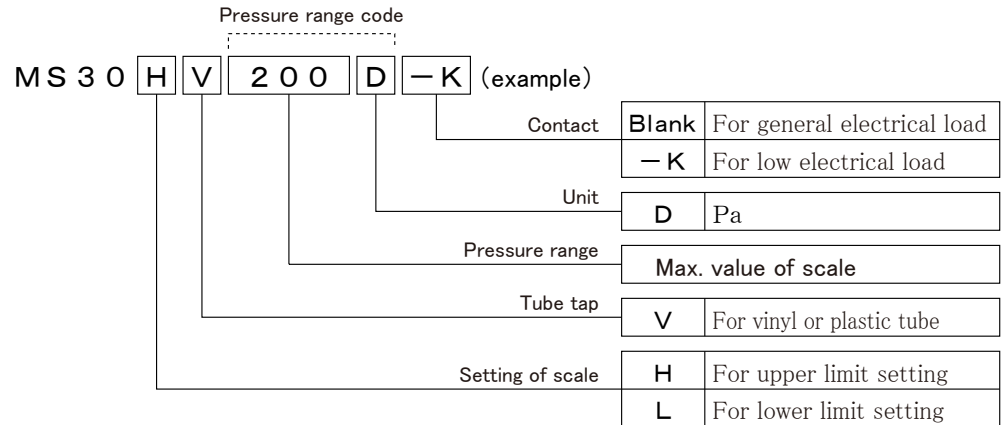

Pressure ranges and characteristics :

Pressure range codes	Pressure ranges	Accuracy of switching point (at 20 °C)	Repeatabilities	Max. switching difference pressures
200 D	For upper limit setting 30 ~ 200 Pa	± 10 Pa	± 2 Pa	30 Pa
	For lower limit setting 20 ~ 200 kPa			
500 D	50 ~ 500 Pa	± 25 Pa	± 5 Pa	40 Pa
1000 D	100 ~ 1000 Pa	± 50 Pa	± 10 Pa	60 Pa

Pressure measuring method : Measuring differential pressure

Pressure receiving element : Diaphragm (silicone rubber)

Gas to be measured : Air, non-corrosive and non-combustible gases (not liquid)

Pressure setting method : Dial with scale

Standard installation position : Vertical

In case of installing horizontal position, set the dial kept to add 20 Pa against setting pressure value.

Medium and ambient : - 10 to + 60 °C (no freezing)  
temperature

Ambient humidity : 90 % RH or less (no dewing)

Withstanding pressure : 10 kPa  
of instrument body

Withstanding pressure : 10 kPa  
of receiving element

Withstanding vibration : 5 to 10 Hz Amplitude : 10 mm ,  
10 to 50 Hz Acceleration : 39 m/ s<sup>2</sup> (each two hours on triaxial directions)

Withstanding impact : 100 m/s<sup>2</sup> (each six times on triaxial directions)

**Insulation resistance** : Between each terminal and case 20 MΩ or more (500 V DC megger)

**Withstand voltage** : Between each terminal and case 1500 V AC 50 / 60 Hz, for one minute

**Material of the outer case** : Polycarbonate

**Applicable piping** : Vinyl, plastic or rubber tube (I.D. 4)

**Tube tap polarity** : The part of tube tap is marking “H” on high pressure side and “L” on low pressure side.

**Electric connector** : mini-clamp Connector 3P (produced by 3M Co., Ltd.)  
The electric connector wiring side is not attachment for a product. When you need it, use the optional electric connector.

**Mass** : Approximately 120 g

**Accessory** : Nil (The plug side connector is an optional extra. Refer to p. 6)

**Conformed standards** : EU directive EMC directive

UL standards UL and C-UL recognition component

1) The applicable request standards ..... UL508

2) File No. .... E240648

RoHS Directive (2002/95/EC)

(Products in compliance with the RoHS carry  **G** or  **[G]** mark on the label of product itself and on each package.)

**Caution** : In case of measuring combustible gas and using in combustible gas area, use with intrinsically safe apparatus construction.

[ For general electrical load ]

Types	Specifications	Rated voltages	Resistive loads	Inductive loads
MS30HV MS30LV	Contact composition SPDT (single pole double throw type) Electrical life 70,000 times or more Material of the contact Silver (round rivets point)	30 V DC	3 A	2 A ( $\begin{matrix} \text{time} \\ \text{constant} \\ 7\text{ms} \end{matrix}$ )

[For low electrical load]

Types	Specifications	Rated voltages	Resistive loads	Inductive loads
MS30HV-K MS30LV-K	Contact composition SPDT (single pole double throw type) Electrical life 100,000 switching cycles Material of the contact Gold alloy (cross point)	30 V DC	0.1 A	—

Rated authorized standard for safety (UL) :

[ For general electrical load ]

Types	Rating
MS30HV MS30LV	DC 2 A-30 V

[For low electrical load]

Types	Rating
MS30HV-K MS30LV-K	DC 0.1 A-30 V

 <b>Caution</b>	<ul style="list-style-type: none"> <li>▪ In case of driving an inductive load such as relay, contact trouble may be happened due to counter electromotive force and rush current, therefore insert the protective circuit for absorbing surge by using diode or varistor (refer to p. 9).</li> <li>▪ In case of low current or voltage, use the low electrical load type. The general electrical load type is decreased contact reliability. (refer to p. 8)</li> </ul>
---	---

**“The withstanding pressure of the pressure receiving element” means ;**  
 The max. pressure under which the diaphragm withstands distortion or breakage (withstand single pressure) The single pressure acting on either H or L side.

**“The withstanding pressure of the instrument body” means ;**  
 The max. pressure under which the instrument body withstand safely without breakage (double side withstanding pressure) The pressure acting on both high and low sides.

**Note :** The withstanding pressure of the instrument body is not the pressure under which the airtightness of the instrument is guaranteed.

### III. INSTALLATION

Before using this instrument, make sure if it is the type that you requested and meets the demand of the environment, pressure and tubing conditions where it is used, by specification.

#### 1. Caution of service condition

- a) Do not use the instrument in a place subjected to direct sunlight, vibration or shock, or excessive moisture. In particular, vibration and shock to the instrument should shorten its life.
- b) Use under the medium and ambient temperature from  $-10$  to  $+60$  °C .
- c) The instrument is not waterproof. Do not use it in a place subjected to rain, or other splashing water.
- d) The instrument cannot be installed outdoors without an appropriate protection. If outdoor installing is required, the instrument should be housed in a box of drip-proof type for outdoor use.
- e) In installing the instrument, select the place where the ground is smooth and flat.

#### 2. Installation of MS30

Panel cut size

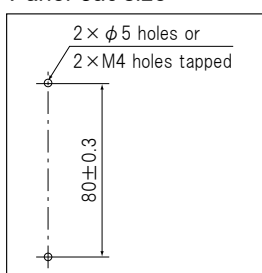

 Caution	<p>Tighten the piping connectors with the torque of 1 N·m. Do not apply excessive torque more than necessary, otherwise it will damage the instrument body.</p>
-------------	---

#### 3. Piping material

Please use I.D 4, the wall thickness of 1 mm or more piping material. Vinyl, plastic or rubber tubes and soft plastic tubes are suitable. When inserting the piping into the tube tap, please push the piping until it stops.

#### 4. Pressure of measurement and connection of piping

##### a) Measurement of positive pressure

Connect the tube to the high pressure side piping connector (indicated by red color or letter H). The lower pressure port (blue or L) should be opened to atmosphere, but do not remove the piping connector.

##### b) Measurement of negative pressure

Connect the tube to the low pressure side piping connector (blue or L). The high pressure port (red or H) should be opened to atmosphere, but do not remove the piping connector.

##### c) Measurement of differential pressure

Connect the tube from the high pressure piping connector to the high pressure port (red or H) and from the low pressure piping connector to the low pressure port (blue or L).

## 5. Caution of piping

### a) Prohibition of common piping

Piping each of pressure detectors and pressure receiving instruments tube exclusively dedicated for it, and do not connect the piping commonly with the adjacent system as shown in the right figure.

Common piping causes measurement error because the pressure of each system interferes.

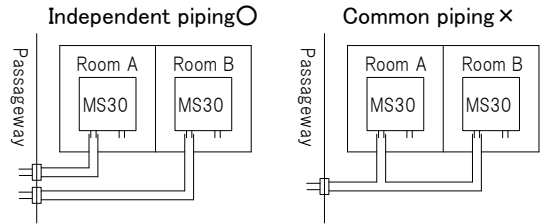

### b) Prevention of clogged piping due to drain

- If drain remains within the line, it causes measurement error. Be sure to install the pressure receiving instrument above the pressure outlet port of the pressure detector and arrange the line so that the drain water should not remain in the slack piping.

- If the arrangement mentioned above is not possible, install a drain tank within the line as shown in the right figure and clean it once in a while.

- After the cleaning of the tank, check that the air tightness is fully kept.

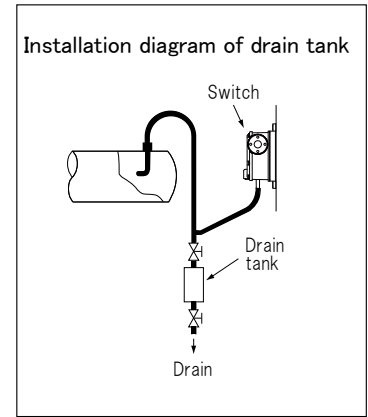

### c) Errors caused by long distance piping

The speed of response is delayed when the product is used for remote monitoring.

In such application, the I.D. of the connection tube should be as large as possible.

The time constant is almost inversely proportional to the inner cross sectional area of the piping.

If the piping conditions of the high and low pressure side are significantly different, the difference in the piping resistance between high and low pressure side causes the difference in pressure transmission time, and the measurement becomes inaccurate.

## 6. Installation position

In ordering out of above mentioned installation position, please order us or our agency beforehand. It must be adjusted before the factory shipment.

## 7. Wiring

- After confirming the specifications of applicable wiring (cross-section of conductor, O.D. of the wire cover), select following the applicable wire.

### Accessory for MS30

- Mini-clamp wiremount plug 3P (produced by 3M Co., Ltd.)

Product code	Color of cover	Applicable cable			Cover
		AWG No.	Nominal cross-sectional area	Wire cover diameter	
37103-2124-000FL	Green	20 ~ 22	0.3 ~ 0.5mm <sup>2</sup>	1.0 ~ 1.2mm	
37103-2165-000FL	Blue			1.2 ~ 1.6mm	
37103-2206-000FL	Gray			1.6 ~ 2.0mm	

- Inserting and clamping of the wire

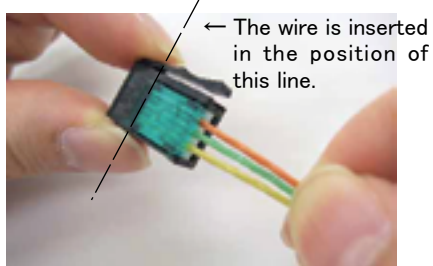

Insert the wire referring to figure of the composition of switch contact on the next page.

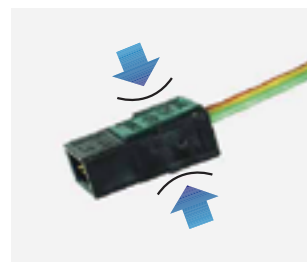

Clamp the electric connector with pliers



## IV . SETTING OF PRESSURE

### 1. Switch contact configuration

- Composition of contact of this instrument is as shown on the right.
- If the instrument is not applied by differential pressure we call such “**normal condition**” .
- At normal condition, the contact between COM. and N.C. is closed, and between COM. and N.O. is open.
- With increase of differential pressure and reaching the actuation pressure, the contact will be changed over ; between COM. and N.C. is opened and between COM. and N.O. is closed.

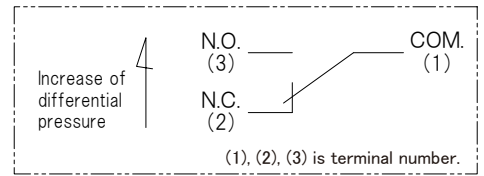

### 2. Setting of upper limit/ lower limit

- When differential pressure applied to the instrument is increased starting from zero and changes over the electric contact from N.C. (normal close) to N.O. (normal open), the pressure at this moment is called “**actuation pressure**” .
- When this differential pressure decreases from the pressure higher than this actuation pressure activating electrical contact and returning the contact from N.O. (normal open) to N.C. (normal close), the pressure at this moment is called “**reset pressure**” .
- There is certain difference between actuation pressure and reset pressure and this is called “**dead band**” .
- There are two types of the instrument. One is called “**upper limit setting type**” type (H) whose scale of setting knob is adjusted on actuation pressure, the other is called “**lower limit setting type**” type (L) which is adjusted on reset pressure.
- Be careful about the difference between the upper and lower limit setting switched and also understand the relation between the pressure increase/ decrease and the contact composition before designing the operational sequence.

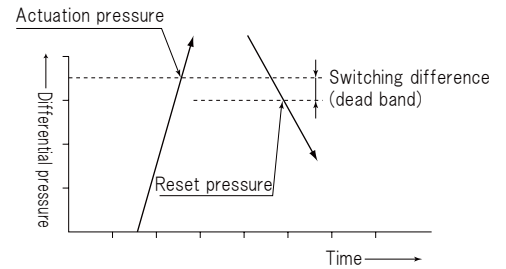

Explanation diagram of switching difference pressure

Depending on the purpose of use, choose the instrument either “ <b>upper limit setting type</b> ” or “ <b>lower limit setting type</b> ”		<b>Difference of contact movement between “upper limit setting type” “lower limit setting type”</b>
	<b>Adjusting of scale</b>	In case of 50–500 kPa range with set value 250 Pa. (dead band is 30 Pa)
<b>Upper limit setting type</b>	Adjusted in activating pressure	<b>In case of “upper limit setting type”</b> When the differential pressure increases, the circuit is closed between N.O. and COM. at 250Pa. Then as the differential pressure decreases, the circuit is opened between N.O. and COM. at 220kPa.
<b>Lower limit setting type</b>	Adjusted in reset pressure	<b>In case of “lower limit setting type”</b> When the differential pressure increases, the circuit is closed between N.O. and COM. at 280Pa. Then as the differential pressure decreases, the circuit is opened between N.O. and COM. at 250Pa.

The scale of the setting knob is adjusted for both upper and lower limit setting type at our factory before shipping. It is not allowed for customers to convert from the upper limit setting to the lower limit setting or vice versa.

 <b>Caution</b>	<p>Do not turn the dial too much exceeding the upper bound or the lower bound of the scale. It causes performance deterioration and the failure.</p>
--------------------	--

### 3. Reset time

The reset time means the time needed for the differential pressure to decline to the reset pressure from the activating pressure (i.e., the electrical contact is reset) when the differential pressure is sharply reduced to zero. It is about three seconds at 20 Pa, and one second at more than 50 Pa for Manostar switches. (This value is only for the instrument itself and does not include the effect of piping.) Therefore, a response quicker than this value is not possible.

## V. ABOUT BUILT-IN MICRO SWITCH

### 1. Material of contact

#### a) Gold alloy contacts ( “for low electrical load” )

Stable contact performance is expected since oxidizing or sulphidizing film is not easily formed on gold alloy contacts. However, they are not suitable for switching the load of high capacity. If used for such applications, the contacts are rapidly damaged due to sticking and blowout

The max. rating of our Manostar switch having gold alloy contact for micro load is 100 mA, 30 V DC, resistive load. Use the switches within the limits of the max. rating and the min. rating.

#### b) Silver or silver alloy contacts ( “for general electrical load” )

In general, the contacts having silver as the main material, which is easy to form surface oxide film and, particularly, sulfide film, contacts work fine in the early stage, but thereafter, on low electrical load such as 10 mA, 24 V DC the firm cannot break. It tends to occur contact failure by the firm.

When the current or voltage applied to the contact is high enough to break the oxide/ sulfide film, is broken and the contact is kept good contact.

### 2. Contact material and applicable mechanism for low voltage and low current circuit

The schematic diagram in the right explains the proper range of load voltage and current for which silver or gold alloy contact is generally used when the contact is used for opening or closing the low voltage and low current circuit with a micro switch. When referring to the diagram, keep the following points in mind.

The working range for each contact may actually be depended on the kind of micro switch, contact pressure, working condition, environmental condition, and the kind of load, and so on.

In general, the contact should be selected based on the required level of contact reliability.

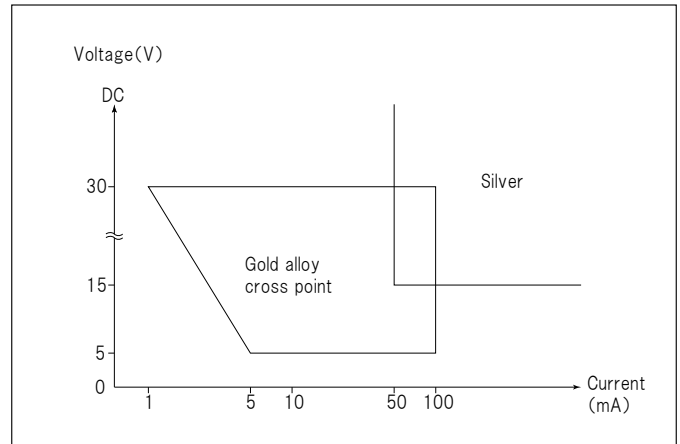

### 3. Protection of contact of switch

- Contact protection circuit is used to extend the service life of contact. It reduces generation of noise at the time of switching on and off. It also minimizes carbide and nitric acid gas generated by arc. Use this circuit correctly, otherwise it will cause reverse effect, making the matter worse.
- In case of using contact protection circuit, pay attention the operating time is possibility of delaying a little. The following are typical examples of contact protection circuit.

#### a) Typical example of protective circuit

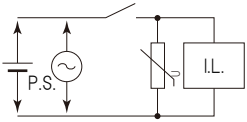
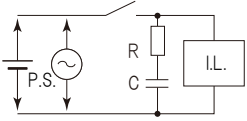
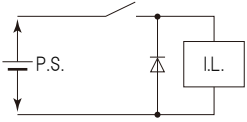
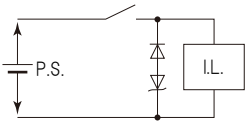
Example of circuit		Special remarks for application and selection
	<b>Varistor method</b>	This method is intended not to apply voltage beyond limit of varistor to inbetween contacts. It delays a little time to return inductive load such as relay. Select the most conformed rated model in terms of power supply voltage and load capacity in selected article by varistor maker.
	<b>C·R method</b>	It delays a little time to activate or return inductive load such as relay. As for CR value, to contact current and contact voltage, the estimate value is $C : 0.5 \mu F / A$ , $R : 1.0 \Omega / V$ . However, it differs according to the characteristics of load, therefore, be sure to confirm to select by experiment.
	<b>Diode method</b>	This method is intended to consume counter electromotive force of inductive load by diode and avoid to apply high voltage to inbetween the contacts. This method makes the return time of inductive load slower. Choose the diode rated current is more than load current and counter withstand voltage more than 10 times of power supply voltage.
	<b>Diode + Zener diode method</b>	Diode method proves to be effective when the return time takes too long for inductive load such as relay. When you choose zener voltage of zener diode, choose base on power supply voltage. Be careful with limitations having this method. Because load is too big, larger capacity zener diode is needed for reverse surge power.

P.S. : Power supply, I.L. : Inductive load

#### b) Example of wrong protection circuit

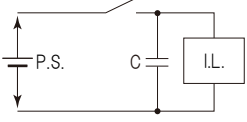
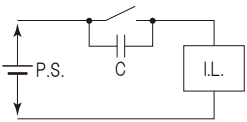
	<b>Condenser method</b>	This is very effective to remove arc at the time of off-contact, but this is likely to run charged current to condenser leading to contact sticking and short service life at the time on-contact.
		This is very effective to remove arc at the time of off-contact, but this is likely to run short circuit current accumulated in the condenser leading to contact sticking on contacting. This is likely to short service life at the time on-contact.

P.S. : Power supply, I.L. : Inductive load

If the load is larger than the specified contact capacity, use a secondary relay. In general, the load voltage and the current is too less to the life of contact is longer. However, this does not expect for a low electrical load. Manostar switches cannot directly shut off the circuit of 250 V AC or more.

#### 4. About measured gas and contact failure

##### a) Corrosive gas

If the gas to be measured contains corrosive gases (nitric acid, hydrogen sulfide, sulfurous acid, ammonia, chlorine, and so on), they may cause electrical contact failure or corrosion of internal mechanism, which leads to malfunction of the switch. Do not use the switch for the gases containing high humid air because in such gases, the arc generated by opening/ closing the contact produces nitric acid, and it may also cause electrical contact failure or malfunction of switches.

##### b) Silicone gas

If the gas to be measured contains silicon produced from silicon (contained in oil, grease, filling agent, and so on), the gas produced by arc, generates by opening/ closing the contact, accumulates on the contact surface and causes contact failure. Take corrective measures such as the removal of the gas source or arc suppression.

##### c) Dust and organic gas

The micro switch used in a Manostar switch is installed in the positive pressure measurement chamber. The gas to be measured can easily flow into the chamber, thus, the composition of the gas largely affects the formation of the film. In addition, the dust contained in the gas to be measured can adhere to the contact surface and be changed into carbide caused the contact failure by the arc generated when the contact is opened or closed. Therefore, pay attention to the measurement environment as well. (Even with gold alloy contact, be careful about the dust.)

 <b>Caution</b>	<p>As the opening/ closing frequency of the contact increases, wear dust from the contact increases. This wear dust accumulates between the contacts to increase the contact resistance and causes the malfunction in the load circuit.</p> <p>In particular, the surrounding where there exists continuous vibration and impact will be most likely to cause contact failure due to worn powder.</p>
---	---

## VI. LINE PART ACCESSORIES

### Pulsating protector

In case of strong turbulent flow of medium air that causes abnormal movement of pointer and output of transmitter, installing a pulsation protector applicable pressure range one each on H side and L side on the piping way between pressure sensor and the instrument.

Product code	Applicable range (max. value)
For vinyl or plastic tube	
RS-VT4-02	200 Pa or less
RS-VT4-03	300, 500, 1000Pa
RS-VT4-04	2, 3, 5, 10kPa

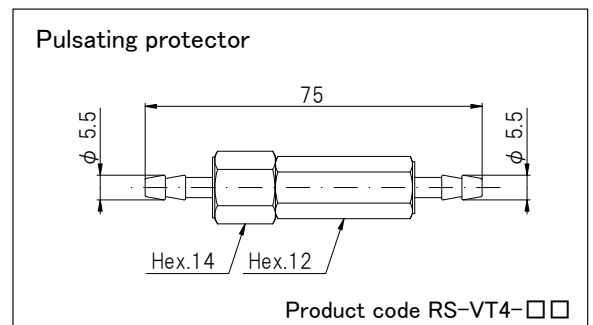

### T joint

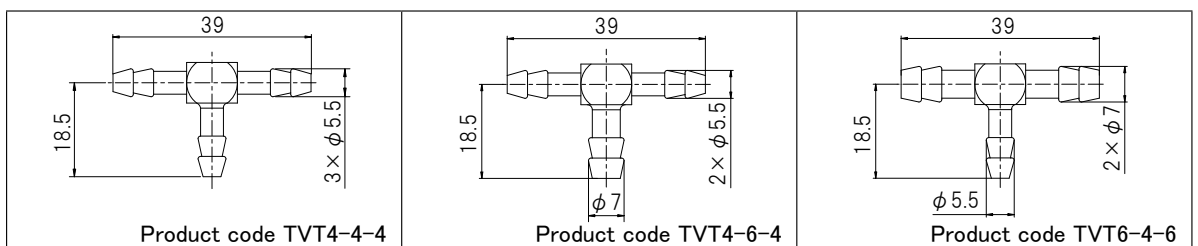

## VII. PERIODIC INSPECTION

Generally speaking, it is important not to exert external stress to keep life and reliability of the instrument for a long time.

Proper use of this instrument will ensure its faultless service over many years without any necessity of periodic lubrication.

However, it is recommended that it is subjected to periodic inspection (calibration) once a year.

## VIII. PRODUCT WARRANTY

### Warranty Period

This product warranty is valid for one year from the date of delivery to a place specified by an ordering party who has transacted directly with Yamamoto Electric Works Co., Ltd.

### Coverage

If a product breaks down due to a reason for which we are responsible during the warranty period and you return the product to us, we will either repair or replace the product free of charge.

This warranty does not cover:

- (1) Usage of the product under any inappropriate conditions or environment contrary to what is described in our product catalog, specifications or manual.  
Handling or usage of the product other than as described in our product catalog, specifications or manual.
- (2) Breakdown due to a reason other than a fault within our product.
- (3) Any product that has been modified or repaired by a party other than us.
- (4) Any breakdown due to a reason that was not foreseeable based on scientific and technical standards applied at the time of shipment.
- (5) Any breakdown due to a reason not attributable to us such as a natural calamity or other disaster.

These terms of warranty represent our entire liability with respect to the product, and we shall have no liability for any other loss arising in connection with a breakdown of the product.

\*This product warranty is only valid within Japan.

This document is a translation from the original Japanese version, and the original Japanese version has priority over this translation.

Be sure to refer to the original Japanese for the details of this warranty.

### <Prior notice>

The specifications and description of the product explained in this instruction manual may be subject to change without prior notice because of modification and the like.